

GEBERIT SHOWER SOLUTIONS

FOR ALL YOUR SHOWER NEEDS

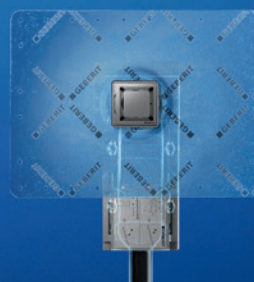

**KNOW
HOW**
INSTALLED

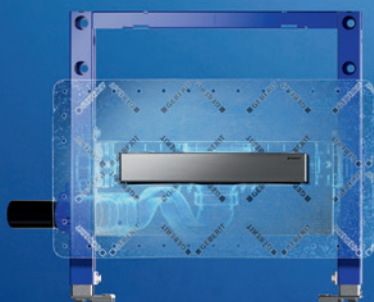
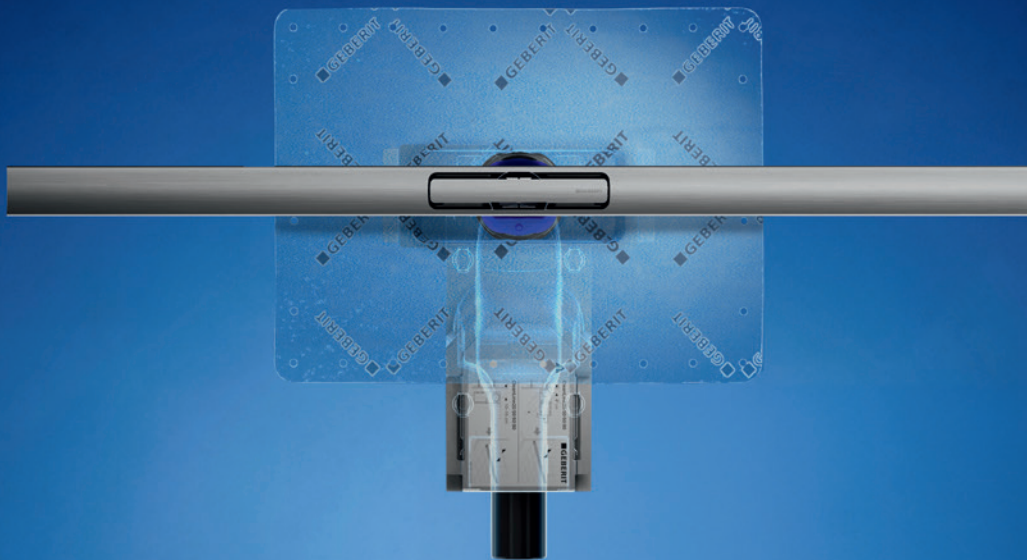

MASTERING WATER

BEHIND THE WALL

INSTALLATION AND FLUSH



Efficient flush and quiet fill with:
Geberit Type 212 flush valve and Geberit Type 383 fill valve

DRAINAGE

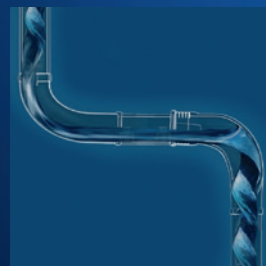

High discharge rate with:
Geberit SuperTube (HDPE) Technology

SUPPLY SYSTEMS

INSTALLATION AND FLUSHING SYSTEMS

WC

WASHBASIN AREA

SHOWER

DRAINAGE SYSTEMS

Geberit uses technical know-how and functional design to use water more easily, safely and efficiently – throughout the entire system.

IN FRONT OF THE WALL

WC



Powerful flush with:
Geberit WCs with TurboFlush technology

SHOWER

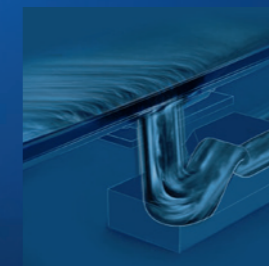

Safe drainage with:
Geberit CleanLineshower channel

The products mentioned are only representative examples of each product category.

CONTENTS



08 **GEBERIT CLEANLINE**
Modern and functional down to the finest detail.

16 **GEBERIT CLEANLINE INSTALLATION SET**
Flexible installation, secure sealing.

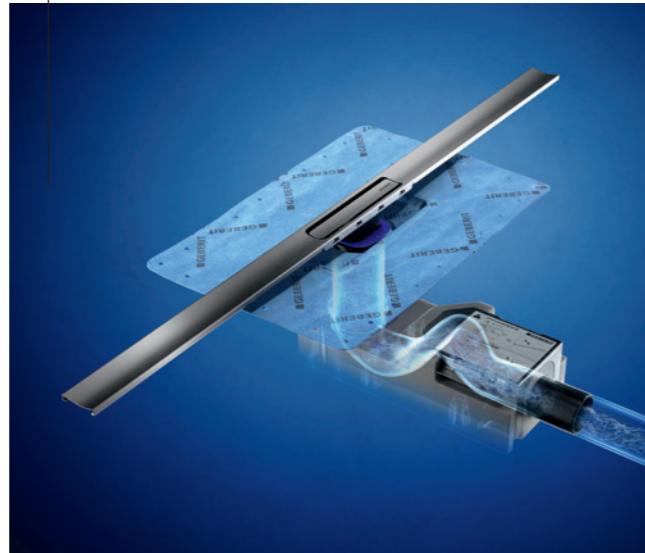

20 **GEBERIT CLEANWALL**
Consistently floor-even.



22 **GEBERIT CLEANPOINT**
Minimalist with high discharge rate.



SHOWER CHANNELS

Geberit CleanLine shower channels combine an outstanding look with function and hygiene, making bathrooms feel more spacious and creating an almost completely seamless floor surface. A range of designs, models and sizes gives you the freedom to create unique looks to suit any bathroom.

GEBERIT CLEANLINE30

MODERN AND FUNCTIONAL DOWN TO THE FINEST DETAIL

Geberit CleanLine30 shower channels are sleek, functional and sophisticated, down to the finest detail. Made of stainless steel, they combine modern design with maximum everyday practicality. The narrow shower channel fits elegantly into any shower surface – either mounted back-to-wall or in-centre.

 Classic brushed stainless steel or on-trend black

 Floor-even access for completely tiled shower areas

 No hidden channels to minimise dirt and bacteria deposits. The removable comb insert makes the drain easy to keep clean

CleanLine30 is available in four lengths from 90 to 160 cm and can be shortened as required. Whether for a new building or renovation, the shower channel comes with two water seal depths, making it suitable for use in any shower area. The shower channel is incredibly easy to keep clean thanks to the floating waste plug with integrated comb insert. The sealing membrane, which is premounted at the factory, ensures a clear separation of trades and makes installation quick and simple.



↑ Can be customised to the width of the showering area and is also suitable for large tile sizes.

- Sleek, functional design with clean lines
- Easy to clean thanks to integrated comb insert
- Two colour options: brushed stainless steel or black with anti-fingerprint coating
- Premounted sealing for quick installation
- Available in four lengths that can be cut to length as required

COLOURS



Cleanline 30
Stainless steel

Cleanline 30
Black Chrome

154.501.KS.1

154.501.TE.1

154.502.KS.1

154.502.TE.1

154.503.KS.1

154.503.TE.1

154.504.KS.1

154.504.TE.1

SIZES

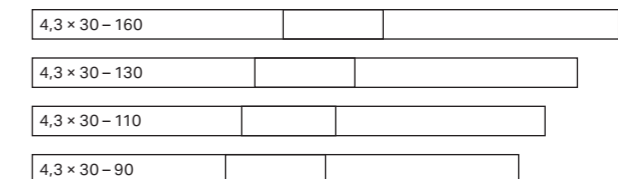

Dimensions in cm



↑ The comb insert, which is easily removable by pressing a button and does not require any additional tools, catches dirt and hair and is easy to clean.



↑ Curved, solid channel profile.

Profile width of 43 mm.
↓



GEBERIT CLEANLINE50

MINIMALIST AESTHETIC IN PERFECT HARMONY



Classic look in brushed stainless steel or contemporary style in black chrome



Floor-even access for completely tiled shower areas



Tiled shower areas

Geberit CleanLine50 is the slimmest member of the Geberit CleanLine family with a modern, minimalist design and width of just 3 cm. Its integrated slope and new triangular contour in the channel cross-section ensure rapid water drainage.



red dot winner 2023

No hidden channels to minimise dirt and bacteria deposits. The removable comb insert makes the drain easy to keep clean.

Just like the other shower channels in this bathroom series, the Geberit CleanLine50 provides an innovative and easy-to-clean water guide to the central drain. Water is openly channelled to the drain via a collector profile. There are no hidden areas, ensuring that dirt and unpleasant odours cannot accumulate. An anti-fingerprint coating makes cleaning even easier: simply wipe the profile down to keep everything clean.

- Extremely slim design
- Triangular profile and integrated slope for fast water drainage
- Anti-fingerprint coating

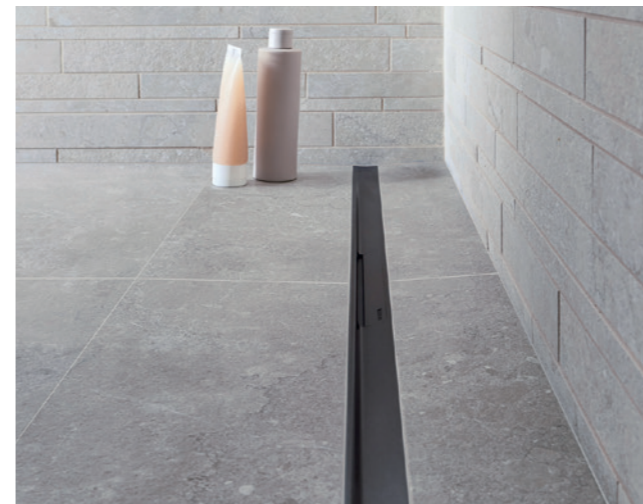

↑ Can be customised to the width of the showering area and is also suitable for large tile sizes.



↑ The comb insert minimises clogging and is easy to remove and clean.

Triangular, solid channel profile for better water drainage.

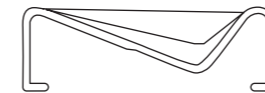

COLOURS



Cleanline 50
Stainless steel

154.446.KS.2



Cleanline 50
Black Chrome

154.446.QC.2

154.448.KS.2

154.448.QC.2

154.447.KS.2

154.447.QC.2

SIZES

3,0 x 30 – 130

3,0 x 30 – 110

3,0 x 30 – 90

Dimensions in cm



GEBERIT CLEANLINE80

PERFECT FORM AND SOLID CONSTRUCTION



Classic stainless steel, on-trend in coloured metallic tones or discreet as a tile-bearing profile



Floor-even access for walk-in shower areas



No hidden channels to minimise dirt and bacteria deposits. The removable comb insert makes the drain easy to keep clean

Made from solid stainless steel, Geberit CleanLine80 shower channels reflect the trend towards coloured metal tones. The integrated slope and anti-fingerprint coating ensure water drains away quickly and make the channel easy to clean.



Classic or trendy: available in black chrome, champagne and brushed stainless steel.

- Modern linear design
- Easy to clean
- Range of designs for different bathroom styles



The comb insert minimises clogging and is easy to remove and clean.

COLOURS



Cleanline 80
Stainless steel

154.440.KS.1

154.442.KS.1

154.441.KS.1



Cleanline 80
Black Chrome

154.440.QC.1

154.442.QC.1

154.441.QC.1



Cleanline 80
Champagne

154.440.39.1

154.442.39.1

154.441.39.1

SIZES

4,4 x 30-130		
4,4 x 30-110		
4,4 x 30-90		

Dimensions in cm

GEBERIT CLEANLINE60

SLIM AND VERSATILE

The CleanLine60 shower channel is suitable for installation in very thin floorings, such as mosaic tiles and synthetic surfaces, thanks to the slim design of the flat stainless steel profile, which blends seamlessly into the floor and lends any shower area a minimalist, elegant appearance.



Classic look in stainless steel



Virtually step-free for fully tiled shower areas



No hidden channels to minimise dirt and bacteria deposits. The removable comb insert makes the drain easy to keep clean

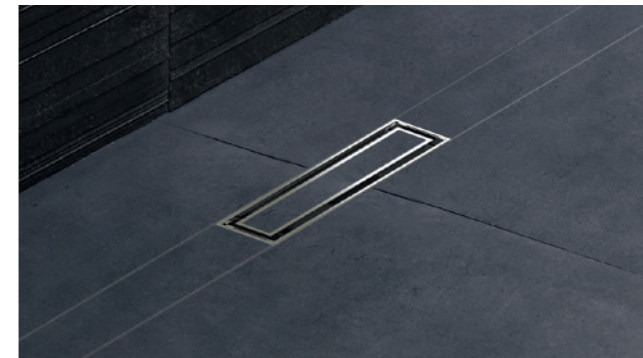

The tile-bearing shower channel integrates almost invisibly into tiled shower areas.

Cleanline Tile bearing
Stainless steel
154.455.00.1

↑
Geberit CleanLine60 for thin flooring.

GEBERIT CLEANLINE20 AND TILE-BEARING

The Geberit CleanLine20 shower channel easily integrates into shower floors thanks to its flat design, creating a floor-even shower area ideal for step-free, accessible installations. The brushed stainless-steel surface is both classically elegant and durable. Geberit CleanLine tile-bearing discreetly and elegantly integrates the drain into shower floors.



↑
CleanLine20: flat design with minimal height offset in shower floors

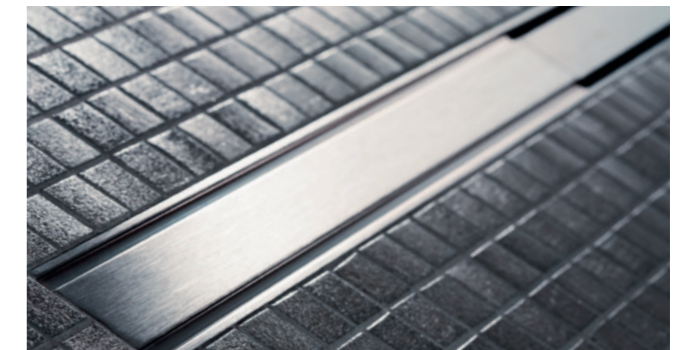

↑
CleanLine60: slimmer design for flat floorings

COLOURS



Cleanline 20
Stainless steel

COLOURS



Cleanline 60
Stainless steel

CLEANLINE20 SIZES

4,3 x 30-160		
154.453.KS.1		
4,3 x 30-130		
154.451.KS.1		
4,3 x 30-110		
154.461.KS.1		
4,3 x 30-90		
154.450.KS.1		

Dimensions in cm

CLEANLINE60 SIZES

4,7 x 30-130		
154.459.00.1		
4,7 x 30-90		
154.458.00.1		

Dimensions in cm

GEBERIT CLEANLINE INSTALLATION SET

ALL SET – NO SWEAT

The smart Geberit CleanLine installation system simplifies the plumber's work and makes installation quick and simple.

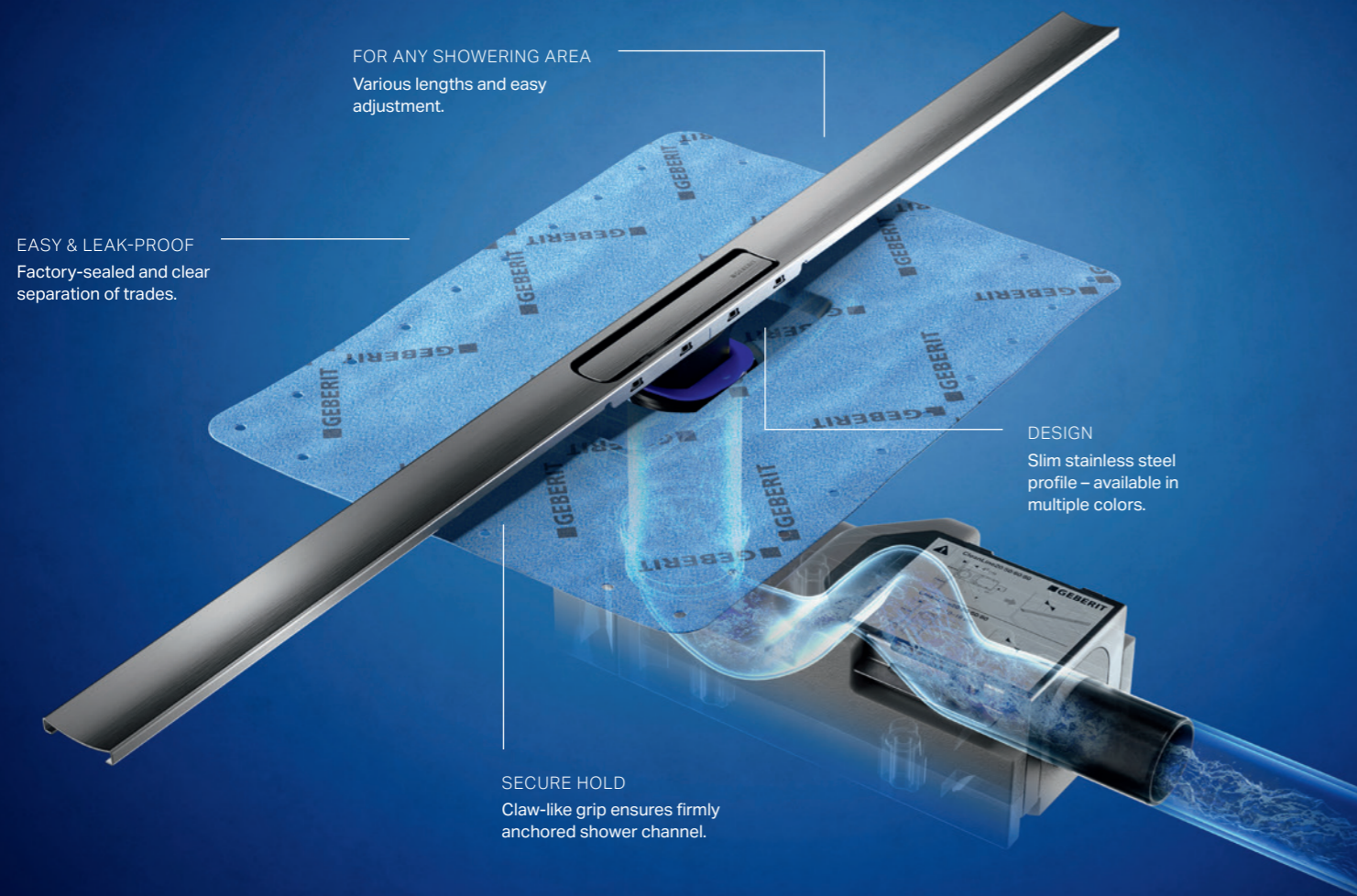

FOR ANY SHOWERING AREA
Various lengths and easy adjustment.

EASY & LEAK-PROOF
Factory-sealed and clear separation of trades.

DESIGN
Slim stainless steel profile – available in multiple colors.

SECURE HOLD
Claw-like grip ensures firmly anchored shower channel.

The timeless linear design of shower channels makes them a great choice for both private and commercial bathroom customers. Geberit CleanLine shower channels offer a range of additional benefits. They are as easy to install as floor drains thanks to their sophisticated technical design. The profile can be integrated into the floor like a tile, which means even tilers can work well with Geberit CleanLine. The ends of each profile can be cut to length, making them easy to adjust to the requirements and measurements of any shower area.

- Classic, discreet, linear design
- Design options suitable for any interior style
- Unique construction with cover profile, central drain and comb insert
- Effortless installation thanks to complete installation set
- Reliable seal thanks to premounted sealing fleece, firmly injection-moulded at the factory
- Easy to adjust thanks to channel profiles that can be cut to length

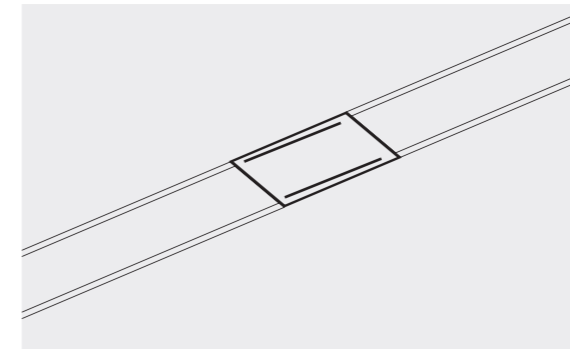

↑
Connecting piece for communal showers makes it easy to install several shower channels seamlessly in a row.



↑
Sound-decoupled base unit to meet strict sound insulation requirements in buildings.



Installation Set
for screed height at inlet
154.152.00.1 - H65
154.150.00.1 - H90

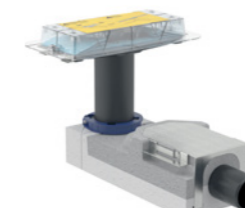

Installation Set
for shower channels
154.159.00.1 - With inlet



Installation Set
for shower channels
154.153.00.1 - Cross floor





POINT AND WALL DRAINS

Geberit shower and wall drains combine a range of benefits, including aesthetic design, modern functionality, high discharge rate and reliable hygiene – perfect for contemporary and convenient bathroom design. Enjoy the comfort of a perfectly matched water guide and discover a wide range of attractive designs.

GEBERIT CLEANWALL

CONSISTENTLY FLOOR-EVEN

-  Continuous floor tiling
-  Floor-even access for fully tiled shower areas
-  No interruption of the floor surface caused by the drain

Geberit CleanWall moves the drainage of floor-level showers from the floor to the wall. This gives shower areas an elegant and modern look, as the floor design can be completely uninterrupted.



↑
The discreet wall drain is easy to keep clean.



↑
You can also tile the Geberit CleanWall cover to match your bathroom design.

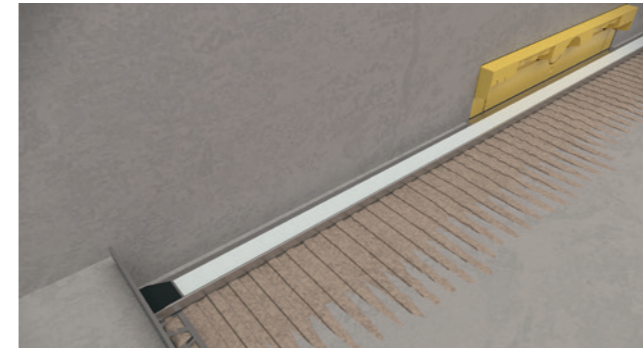

↑
The optional collector profile can be mounted directly in front of the wall to create a slope towards the wall drain, collecting dirt and deposits that are easy to wipe away.



←
A comb insert behind the design cover traps hair and is easy to remove for cleaning.

SIZES

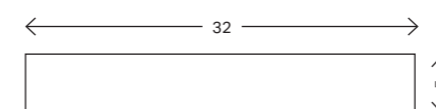

Dimensions in cm



- Innovative solution for integration in prewall systems
- Clear separation of trades thanks to pipe placement behind the wall
- Optional collector profile for efficient and precise formation of the slope in the floor

Geberit CleanWall allows shower surfaces and drainage to create the perfect seamless look. Floors can be designed without any channels or drains, making it ideal for accessible, step-free shower areas. Wall coverings in various colours, including stainless steel, plastic and tile-bearing options, provide freedom of design. Installation is easy because all the elements you need for water supply and drainage are located on one installation level.

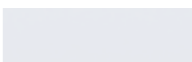
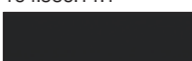
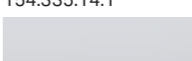
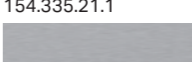

↑
Geberit CleanWall works perfectly with the Geberit GIS, Duofix and Kombifix installation systems.

COLOURS

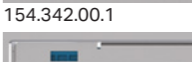
-  White alpine
154.335.11.1
-  Black matt
154.335.14.1
-  Bright chrome-plated
154.335.21.1
-  Brushed stainless steel
154.336.FW.1
-  Polished stainless steel
154.342.00.1
-  Profile for flush wall tiling
154.339.00.1

GEBERIT CLEANPOINT

MINIMALIST WITH HIGH DISCHARGE RATE



Geberit CleanPoint is the classic solution for draining floor-even showers, offering an exceptional discharge rate with a flat trap structure and easy positioning thanks to its compact design with a grating area of just 8 x 8 cm.

 All cover types

 Various design covers

 Step-free access for floor-even shower areas

The design cover of the shower floor drain is available in round and square versions and can be screwed on.
↓



154.311.00.1

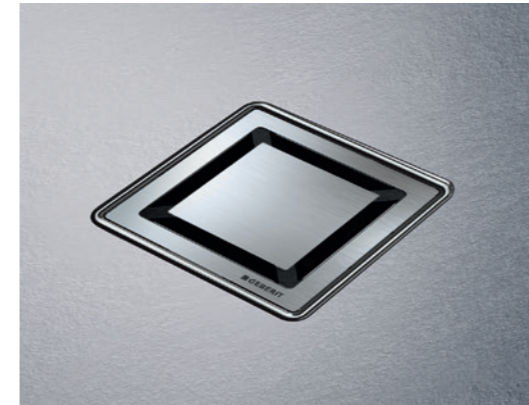

154.312.00.1



243.120.00.1

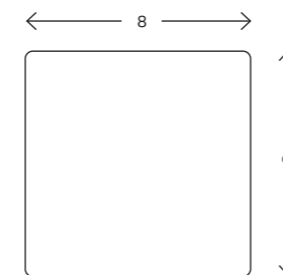

Dimensions in cm

- Intelligent details for simple installation
 - Design grating made of solid stainless steel
 - Compact structure
 - Reliable seal with sealing foil injected at the factory
- Geberit CleanPoint for showers sets itself apart thanks

to its extremely compact design with a grating area of only 8 x 8 cm and exceptional functionality. The height, inclination and offset of the grating can be adjusted to suit the tile grid.

A comb insert serves as a hair trap to prevent clogging.
→

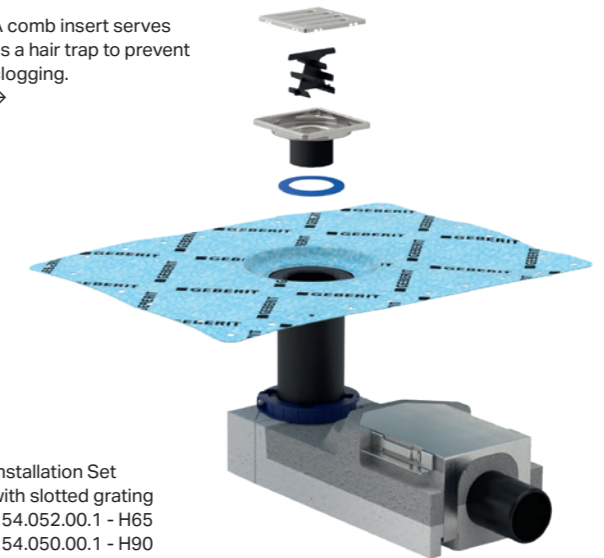

Installation Set
with slotted grating
154.052.00.1 - H65
154.050.00.1 - H90

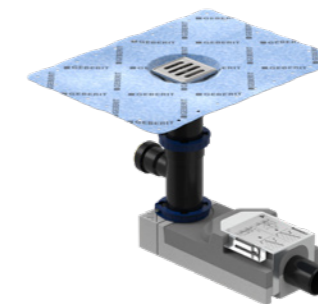

Installation Set
with slotted grating
154.059.00.1 - With Inlet

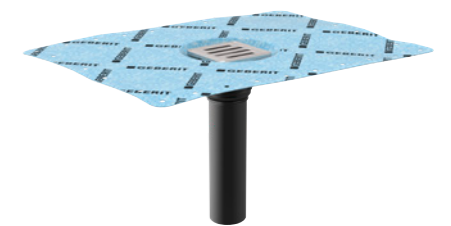

Installation Set
with slotted grating
154.053.00.1 - Cross floor

**Geberit South East Asia Pte Ltd
Regional Headquarters**

Aperia Tower 1
8 Kallang Avenue, #17-09
Singapore 339509

T +65 6250 4011
F +65 6250 4211
sales.sg@geberit.com

www.geberit.com.sg

South Korea Office

#301 JS Building, 213-5 Nonhyun-Dong,
Gangnam-Gu, 135-090 Seoul,
South Korea

T +82 2 543 4166
F +82 2 543 4123
sales.kr@geberit.com

www.geberit.co.kr

Hong Kong Office

Unit B, 11th Flr, CKK Commercial Centre,
289 Hennessy Road, Wan Chai
Hong Kong

T +852 2575 5960
F +852 2575 2667
sales.hk@geberit.com

Taiwan Office

4F-6, No.57, Sec 1, Dunhua S. Road,
Songshan Dist., Taipei City 10557,
Taiwan

T +886 2 2579 8736
F +886 2 2577 3365
sales.tw@geberit.com

Indonesia Office

CIBIS 9 Building, 11th floor, unit W5B
Jl. TB Simatupang No.2
South Jakarta, 12560
Indonesia

T +62 2150812727
sales.sg@geberit.com

Thailand Office

True Digital Park West, Unit SH572, 5th
level 111 Sukhumvit Road, Bangchak,
Phra Khanong, TH-10260 Bangkok
Thailand

T +66 91451 9464
sales.sg@geberit.com

Malaysia Office

Q Sentral, Level 35-02 (East Wing)
2A, Jalan Stesen Sentral 2, KL Sentral,
Kuala Lumpur 50470
Malaysia

T +60 3 2731 9228
F +60 3 2731 9399
sales.sg@geberit.com

Vietnam Office

9th Floor, WorkPlace PL2,
16 Nguyen Truong To Street,
Ward 12, District 4,
Ho Chi Minh City
Vietnam

sales.sg@geberit.com

Philippines Office

Unit 4104, Regus GT Tower, 41/F
GT Tower Building, Ayala Ave., cor dela
Costa St., Makati City, Metro Manila, 1224
Philippines

T: +63 2 8651 6546
F +63 2 840 6501
sales.sg@geberit.com